

**NKI15/16-XL**

Needle roller bearing

Schaeffler ID:
0507619600000

Needle roller bearings NKI, light series

X-life

Technical information

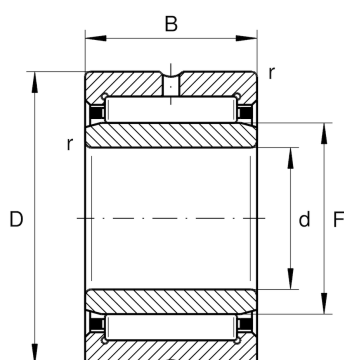
**Main Dimensions & Performance Data**

d	15 mm	Bore diameter
D	27 mm	Outside diameter
B	16 mm	Width
C_r	14,700 N	Basic dynamic load rating, radial
C_{0r}	17,400 N	Basic static load rating, radial
C_{ur}	3,250 N	Fatigue load limit, radial
n_G	21,600 1/min	Limiting speed
n_{gr}	12,400 1/min	Reference speed
	39.79 g	Weight

Dimensions

F	19 mm	Raceway diameter inner ring
r_{min}	0.3 mm	Minimum chamfer dimension
s	0.5 mm	Axial displacement

Temperature range

T_{min}	-30 °C	Operating temperature min.
T_{max}	120 °C	Operating temperature max.